

Key performance:

- $V_{CE}=1200V$
- $I_C=75A@T_C=100^{\circ}C$
- $V_{CE(sat)}=1.7V$

Features:

- Trench and field-stop technology
- Easy parallel switching capability
- Short circuit withstand time 10 μ s
- Low V_{CEsat}
- High ruggedness performance
- RoHS compliant

Applications:

- servo drive
- Inverters

Package parameters

Type	Marking	Package	Packaging Method
JJT75N120SA	T75120SA	TO-247PLUS	Tube

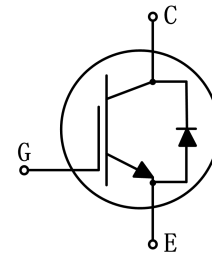
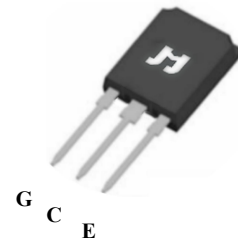
TO-247PLUS

Maximum ratings

Symbol	Parameter	Values	Unit
V_{CES}	Collector-emitter voltage	1200	V
V_{GES}	Gate-emitter voltage	±20	V
I_C	Continuous collector current ($T_C=25^\circ\text{C}$)	150	A
	Continuous collector current ($T_C=100^\circ\text{C}$)	75	A
I_{CM}	Pulsed collector current, t_p limited by T_{vjmax}	300	A
I_F	Diode continuous forward current ($T_C=100^\circ\text{C}$)	75	A
I_{FM}	Diode maximum current, t_p limited by T_{vjmax}	150	A
t_{sc}	Short circuit withstand time	10	µs
P_{tot}	Power dissipation ($T_C=25^\circ\text{C}$)	938	W
	Power dissipation ($T_C=100^\circ\text{C}$)	469	W
T_{vj}	Operating junction temperature range	-40 to +175	°C
T_{stg}	Storage temperature range	-55 to +150	°C

Thermal characteristics

Symbol	Parameter	Values		Unit
		Typ.	Max.	
$R_{th(j-c)}$	Thermal resistance, junction to case for IGBT	-	0.16	K/ W
$R_{th(j-c)}$	Thermal resistance, junction to case for Diode	-	0.55	K/ W
$R_{th(j-a)}$	Thermal resistance, junction to ambient	-	40	K/ W

Electrical characteristics of IGBT ($T_{vj}=25^{\circ}\text{C}$ unless otherwise specified)

Static characteristics

Symbol	Parameter	Test condition	Values			Unit
			Min.	Typ.	Max.	
BV_{CES}	Collector-emitter breakdown voltage	$V_{GE}=0\text{V}, I_C=250\mu\text{A}$	1200	-	-	V
I_{CES}	Collector-emitter leakage current	$V_{CE}=1200\text{V}, V_{GE}=0\text{V}$	-	-	100	μA
I_{GES}	Gate leakage current, forward	$V_{GE}=20\text{V}, V_{CE}=0\text{V}$	-	-	100	nA
	Gate leakage current, reverse	$V_{GE}=-20\text{V}, V_{CE}=0\text{V}$	-	-	-100	nA
$V_{GE(th)}$	Gate-emitter threshold voltage	$V_{GE}=V_{CE}, I_C=1\text{mA}$	5.0	5.5	6.0	V
$V_{CE(sat)}$	Collector-emitter saturation voltage	$V_{GE}=15\text{V}, I_C=75\text{A}$	-	1.7	-	V
		$V_{GE}=15\text{V}, I_C=75\text{A}, T_{vj}=175^{\circ}\text{C}$	-	2.2	-	V

Dynamic characteristics

Symbol	Parameter	Test condition	Values			Unit
			Min.	Typ.	Max.	
C_{ies}	Input capacitance	$V_{CE}=30\text{V}$ $V_{GE}=0\text{V}$ $f=1\text{MHz}$	-	6800	-	pF
C_{oes}	Output capacitance		-	350	-	pF
C_{res}	Reverse transfer capacitance		-	60	-	pF
Q_g	Total gate charge	$V_{CC}=960\text{V}$ $V_{GE}=15\text{V}$ $I_C=75\text{A}$	-	420	-	nC

Switching characteristics

Symbol	Parameter	Test condition	Values			Unit
			Min.	Typ.	Max.	
$t_{d(on)}$	Turn-on delay time	$V_{CC}=600V$ $V_{GE}=0/15V$ $I_C=75A$ $R_G=10\Omega$ Inductive load	-	86	-	ns
t_r	Rise time		-	186	-	ns
$t_{d(off)}$	Turn-off delay time		-	520	-	ns
t_f	Fall time		-	84	-	ns
E_{on}	Turn-on energy		-	11.9	-	mJ
E_{off}	Turn-off energy		-	4.7	-	mJ
E_{ts}	Total switching energy		-	16.6	-	mJ
$t_{d(on)}$	Turn-on delay time	$V_{CC}=600V$ $V_{GE}=0/15V$ $I_C=75A$ $R_G=10\Omega$ Inductive load $T_{vj}=175^\circ C$	-	84	-	ns
t_r	Rise time		-	194	-	ns
$t_{d(off)}$	Turn-off delay time		-	580	-	ns
t_f	Fall time		-	63	-	ns
E_{on}	Turn-on energy		-	17.5	-	mJ
E_{off}	Turn-off energy		-	6.8	-	mJ
E_{ts}	Total switching energy		-	24.3	-	mJ

Electrical characteristics of Diode ($T_{vj}=25^{\circ}\text{C}$ unless otherwise specified)

Symbol	Parameter	Test condition	Values			Unit
			Min.	Typ.	Max.	
V_F	Diode forward voltage	$I_F=75\text{A}$	-	1.8	-	V
		$I_F=75\text{A}, T_{vj}=175^{\circ}\text{C}$	-	1.5	-	V
t_{rr}	Diode reverse recovery time	$V_R=600\text{V}$ $I_F=75\text{A}$ $di_F/dt=-200\text{A}/\mu\text{s}$	-	364	-	ns
I_{rrm}	Diode peak reverse recovery current		-	11	-	A
Q_{rr}	Diode reverse recovery charge		-	2300	-	nC
t_{rr}	Diode reverse recovery time	$V_R=600\text{V}$ $I_F=75\text{A}$ $di_F/dt=-200\text{A}/\mu\text{s}$ $T_{vj}=175^{\circ}\text{C}$	-	576	-	ns
I_{rrm}	Diode peak reverse recovery current		-	23	-	A
Q_{rr}	Diode reverse recovery charge		-	8300	-	nC

Typical performance characteristics

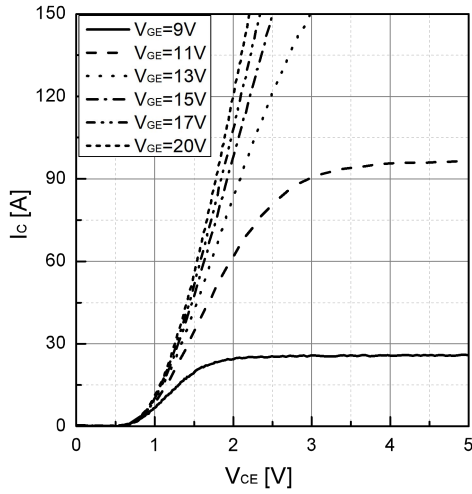

Fig 1. Typical output characteristic ($T_{vj}=25^{\circ}\text{C}$)

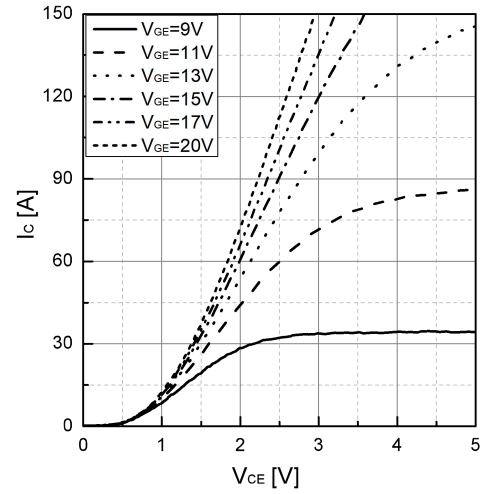

Fig 2. Typical output characteristic ($T_{vj}=175^{\circ}\text{C}$)

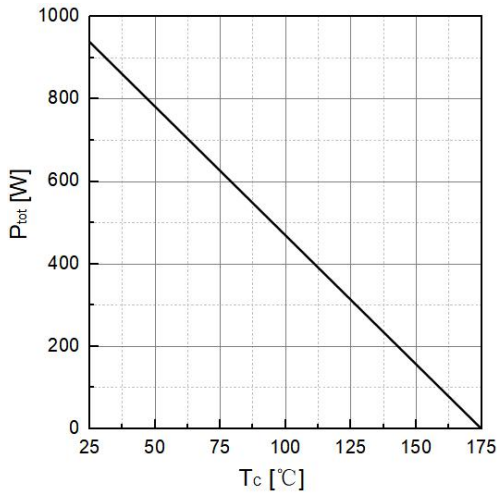

Fig 3. Power dissipation as a function of T_c

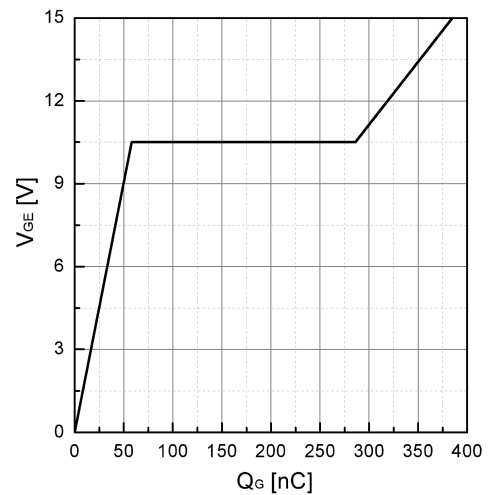

Fig 4. Typical Gate charge

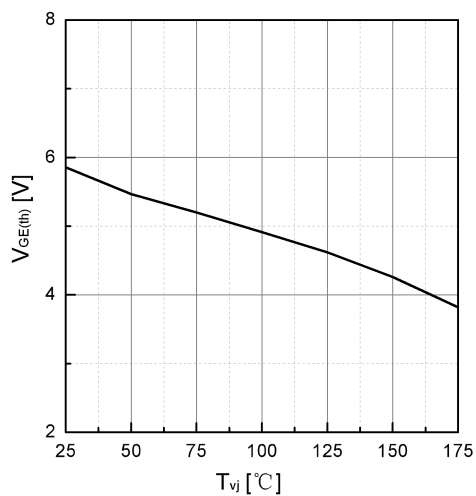

Fig 5. Typical $V_{GE(th)}$ as a function of T_{vj}
($I_C=1\text{mA}$)

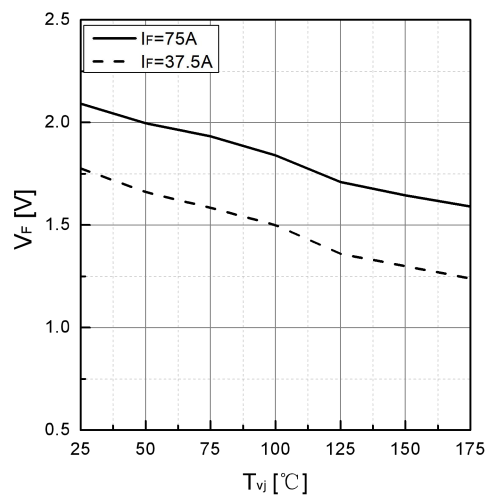

Fig 6. Typical V_F as a function of T_{vj}

Typical performance characteristics

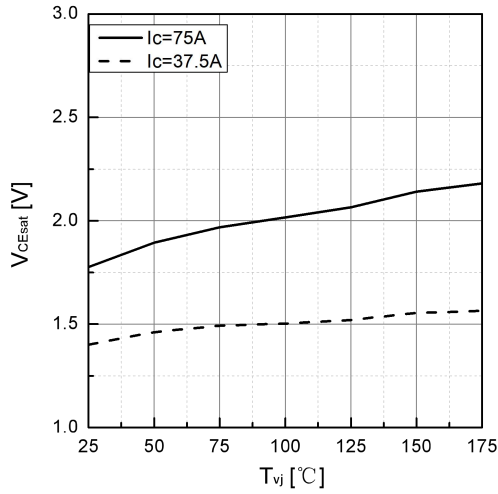

Fig 7. Typical V_{CEsat} as a function of T_{vj}

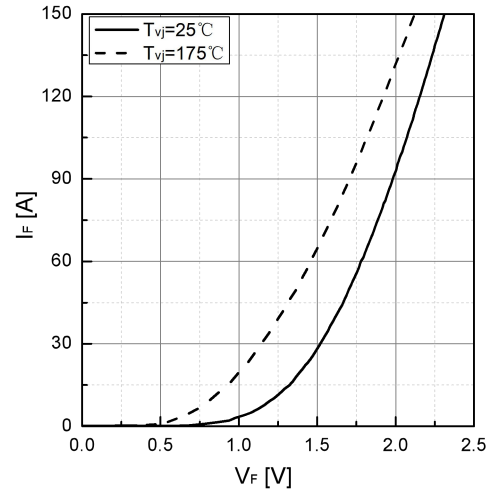

Fig 8. Typical I_F as a function of V_F

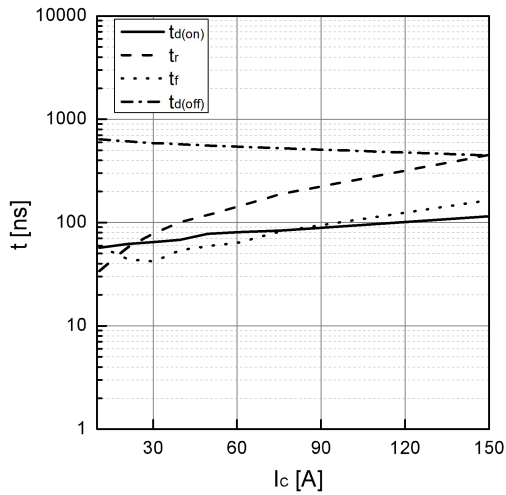

Fig 9. Typical switching time as a function of I_c

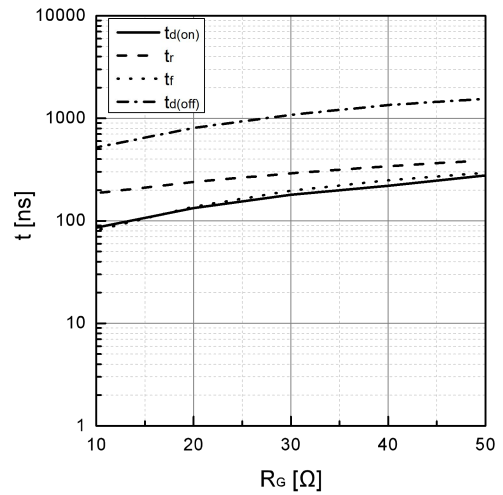

Fig 10. Typical switching times as a function of R_G

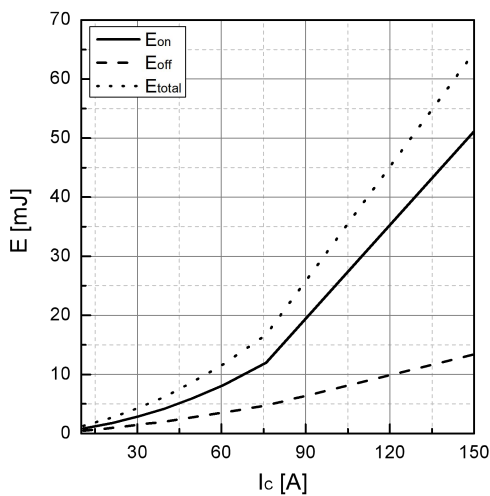

Fig 11. Typical switching energy losses as a function of I_c

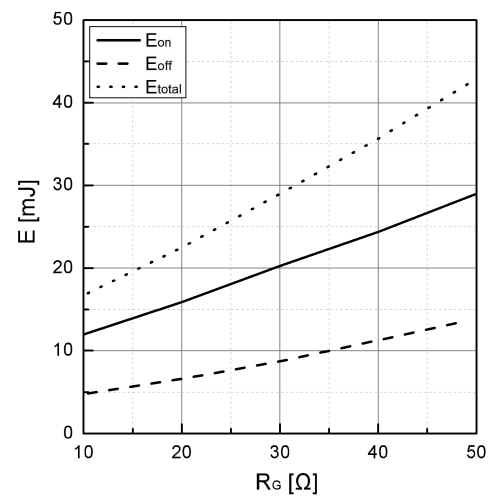

Fig 12. Typical switching energy losses as a function of R_G

Typical performance characteristics

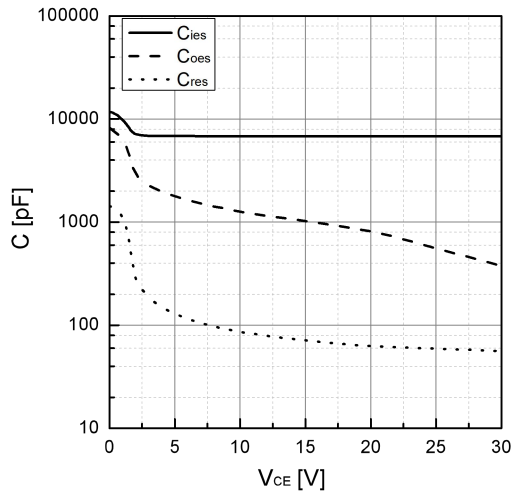

Fig 13. Typical capacitance as a function of V_{CE}
($f=1\text{MHz}$, $V_{GE}=0\text{V}$)

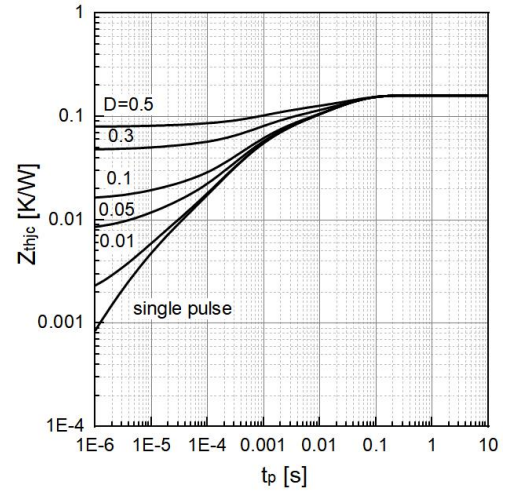
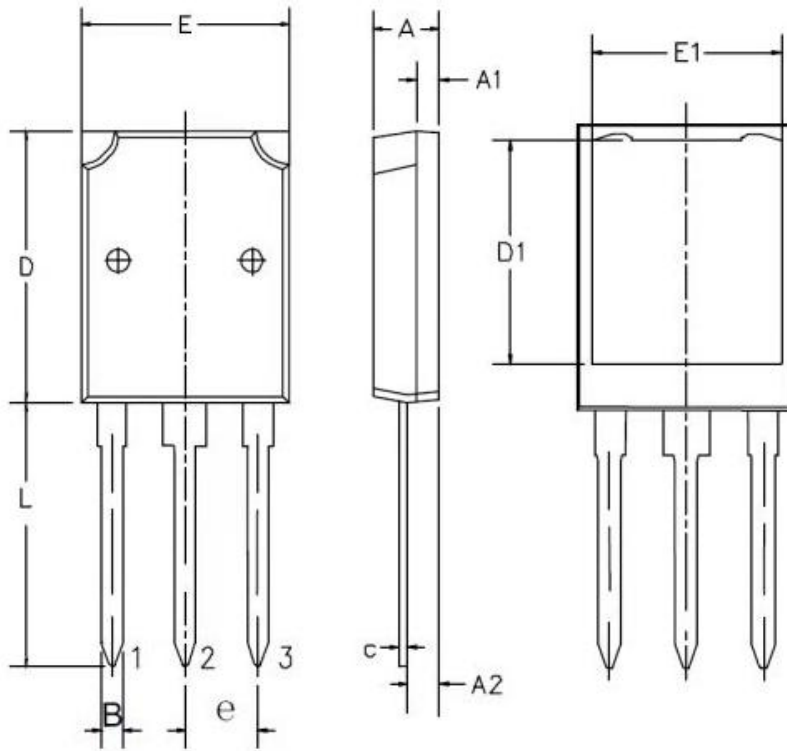

Fig 18. Transient thermal impedance of IGBT

Package dimension

TO-247PLUS



Ref.	Min.(mm)	Typ.(mm)	Max.(mm)
A	4.92	5.00	5.08
A2	2.27	2.35	2.43
A1	1.92	2.00	2.08
B	1.16	1.20	1.24
C	0.56	0.60	0.64
D	20.70	20.90	21.1
E	15.80	15.90	16.00
E1	13.92	14.02	14.12
e	5.34	5.44	5.54
L	19.80	20.00	20.20

Revision history

Date	Revision	Changes
2024-08-26	Rev. 1.2	Update
2025-02-17	Rev. 1.3	Modify the package size
2025-03-03	Rev. 2.0	Replace sketch
2025-06-26	Rev. 2.1	Add thermal figure

Disclaimer

PLEASE NOTE - Jiangsu JieJie Microelectronics Co., Ltd ("JJM") reserves the right to amend, correct, modify and enhance the product and/or this document at any time without prior notice. If you intend to purchase this product, please obtain the latest information available before placing your order. The sale of JJM products is governed by JJM's prevailing terms and conditions at the time of purchase and purchasers are solely responsible for the selection and use of the products with no liability on JJM's part to supply application assistance or customization. Purchase of JJM products does not grant the purchaser license, express or implied, to JJM's intellectual property. Any warranties provided with JJM products are null and void upon resale unless accompanied by the information set forth herein in its entirety. The JJM name and logo are registered trademarks of Jiangsu JieJie Microelectronics Co., Ltd. This document supersedes all previous versions. ©2025 JJM - All rights reserved